

Serie 600 - 610

Centralini modulari da parete.

Wall mounting modular enclosures.

Coffret montage en saillie.

Cuadros de superficie.

N. moduli Modules no. N. modules N. módulo	DIMENSIONI ESTERNE EXTERNAL DIMENSIONS DIMENSIONS EXTERNE DIMENSIONES EXTERIORES			Potenza dissipabile Dispersible power Puissance Potencia disipada
	B (mm)	H (mm)	P (mm)	W
2	50	130	85	5
4	90	130	85	6
	150	170	100	11
8	200	180	100	15
12	280	220	100	23
18	400	265	130	25
24	280	350	100	34
36	400	400	130	58
54	400	600	130	79

Ed. 2017









Serie 600 - 610 IP40

Centralini modulari da parete.

Wall mounting modular enclosures.

Coffret montage en saillie.

Cuadros de superficie.

							
N. moduli Modules no. N. modules	N. módulos RAL7035	RAL7035	RAL7035	RAL9001	Kit morsettiere Terminal blocks kit Equipement Regletas	Support morsettiere Terminal block support Support barrette Soporte Regletas	Morsettiere Barrette Regletas
2	EC61002						
4	EC61003						
4		EC61004	EC60004	EC60004B	EC6004EQ	EC67004	
		EC61004E	EC60004E	EC60004BE			1x4
8		EC61008	EC60008	EC60008B	EC6008EQ	EC67004	
		EC61008E	EC60008E	EC60008BE			1x8
12		EC61012	EC60012	EC60012B	EC6012EQ	EC67012	
		EC61012E	EC60012E	EC60012BE			1x12
18		EC61018	EC60018	EC60018B	EC6012EQ	EC67012	
		EC61018E	EC60018E	EC60018BE			1x12
24		EC61024	EC60024	EC60024B	EC6024EQ	EC67012	
		EC61024E	EC60024E	EC60024BE			2x12
36		EC61036	EC60036	EC60036B	EC6036EQ	EC67012	
		EC61036E	EC60036E	EC60036BE			3x12
54		EC61054	EC60054	EC60054B	EC6054EQ	EC67012	
		EC61054E	EC60054E	EC60054BE			4x12



ELETTROCANALI S.p.a. - Via Generale Dalla Chiesa, 18 - 24020 SCANZOROSCIATE (BG) Italia

+39 035 665077/668264 +39 035 655475/6590705 info@elettrocanali.com

www.elettrocanali.com

Serie 600 - 610

Istruzioni di montaggio.
Installation instructions.
Instructions d'installation.
Instrucciones de montaje.

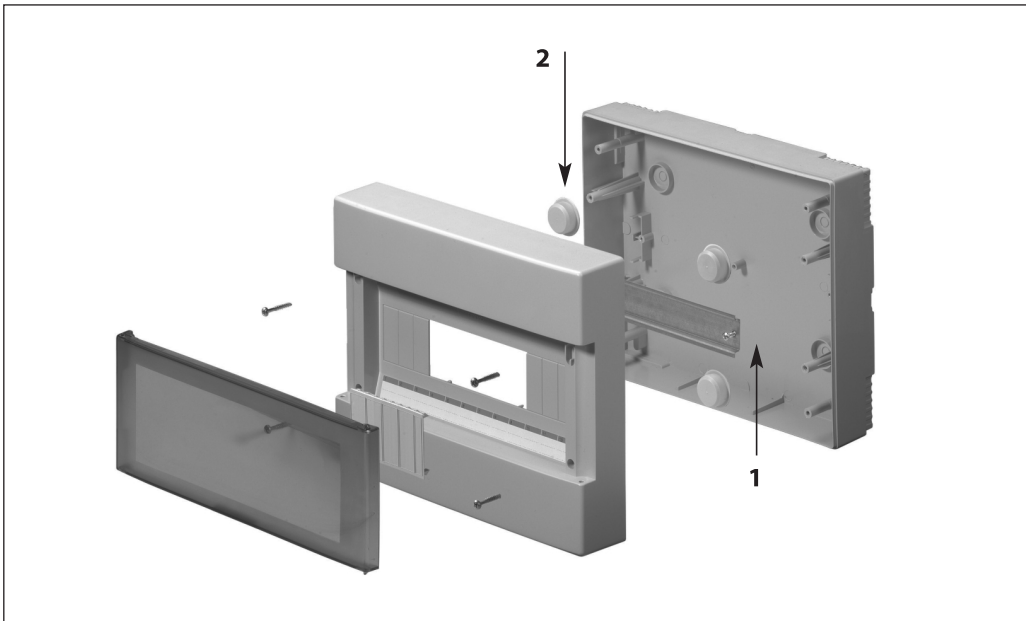

1
Possibilità di installare apparecchi con profondità di 48 o 75 mm.
Possibility to install equipments with a depth of 48 or 75 mm.
Capacité d'installer appareilles avec une profondeur de 48 ou 75 mm.
Posibilidad de instalar protecciones de 48 ó 75 mm.

2
Copertura per moduli e tappi copri fori di fissaggio a garanzia del doppio isolamento.
Blank cover for empty modules and plastic caps for the holes of the fixing screws in the back to gain double insulation.
Couverture pour les modules couvre-chaussure couvre des trous de fixation et de veiller à ce double isolation.
Cobertura para cubrir los módulos y la fijación de topes de los agujeros para garantizar la doble aislamiento.

Serie 600 - 610

Caratteristiche tecniche.
Technical features.
Cahier des charges.
Caracteristicas tecnicas.

Riferimenti normativi: IEC 60670-1/24 - CEI 23-48 - CEI 23-49 - V1/2000 - V2/2003.
 Idoneo a essere montato con isolamento completo.
Tensione nominale: 400 V - Corrente nominale: max. 125A.
Ingresso conduttori mediante tubi fino a 40 mm.
Possibilità di installare apparecchi con profondità di 48 o 75 mm.
Porta smontabile, frontale reversibile.
Gamma da 2 a 54 moduli DIN EN 50022.

Reference Standards: IEC 60670-1/24 - CEI 23-48 - CEI 23-49 - V1/2000 - V2/2003.
 Suitable to be mounted with complete isolation.
Nominal voltage: 400 V - Nominal curren: max. 125A.
Conductor inlet through conduits up to 40 mm.
Possibility to install equipments with a depth of 48 or 75 mm
Removable door, reversing front.
Range from 2 to 54 modules according to DIN EN 50022.

Références normatives: IEC 60670-1/24 - CEI 23-48 - CEI 23-49 - V1/2000 - V2/2003.
 Convient à être équipé d'un isolement complet.
Tension nominale: 400 V - Rated: max. 125A.
Entrée par le biais de conducteurs tubes jusqu'à 40 mm.
Capacité d'installer appareilles avec une profondeur de 48 ou 75 mm
Porte amovible, devant réversible.
Gamme de 2 à 54 modules DIN EN 50022.

Referencia normativa: IEC 60670-1/24 - CEI 23-48 - CEI 23-49 - V1/2000 - V2/2003.
 Idoneo para ser montado con aislamiento completo.
Tension Nominal: 400 V - Corriente nominal: max. 125A.
Ingreso de conductores por medio de caño de hasta 40 mm de diametro.
Posibilidad de instalar protecciones de 48 ó 75 mm.
Puerta desmontable, frente reversible.
Gama de 2 a 54 modulos DIN EN 50022.